





10/03/21

LEGEND

-  SEWER MAIN & ACCESS POINT
-  STORMWATER & PITS
-  50.0 DESIGN CONTOUR & LEVEL
-  Max. 1m RETAINING WALL

- (A) EASEMENT FOR DRAINAGE 1.5 WIDE
- (B) EASEMENT FOR MAINTENANCE & REPAIRS 0.9 WIDE
- (E) EASEMENT FOR PAD MOUNT SUBSTATION 2.75 x 5.5
- (F) RESTRICTION ON USE OF LAND (In relation to fire rating of buildings)
- (G) RESTRICTION ON USE OF LAND (In relation to swimming pools)

NOTE:
ALL CONTOURS HAVE INTERVAL OF 0.5m
(Contours are approximate only)

* AREA SUBJECT TO FINAL SURVEY
* BEARING AND DISTANCES SUBJECT TO FINAL SURVEY



A4 1:250



 Sales Centre:
285 Annangrove Road, Rouse Hill

rousehillheights.com.au



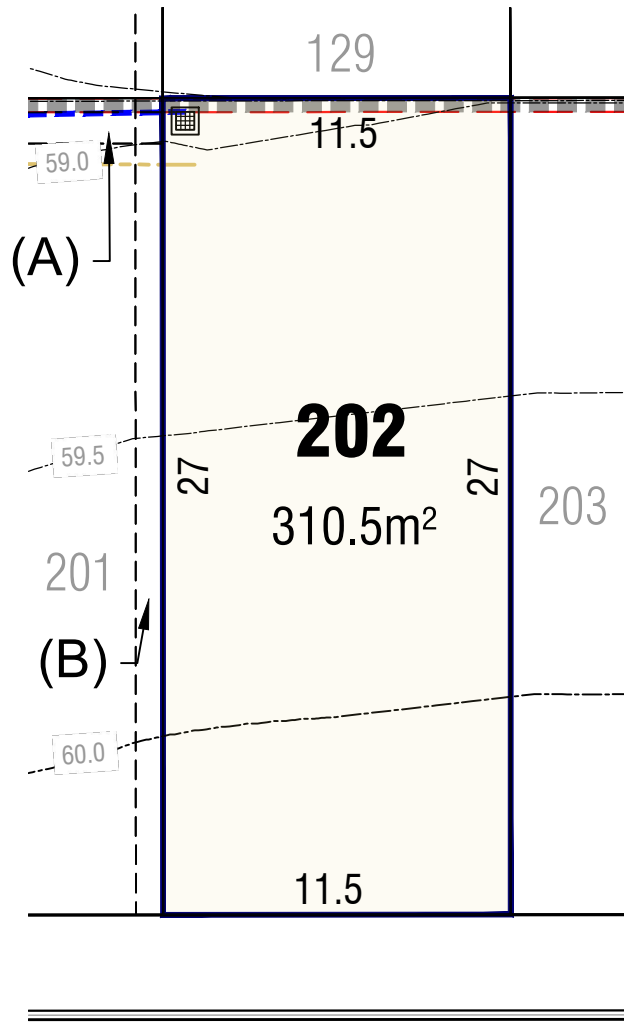

This plan is provided solely for the purpose of providing an impression of the concept relating to the proposed development called 'Rouse Hill Heights', as well as the approximate location of existing and proposed third party facilities, services or destinations and is not intended to be used for any other purpose. Legacy Property does not make any representations or give any warranty in relation to the future development of the site, the staging of any future development or the current or future location or existence of any facilities, services or destinations. The plan is based on the present intention of, and information available to, Legacy Property and the current known requirements of relevant authorities at the time of creation of the plan and details may change due to future circumstances. Any indications of distance or size are approximate and for indicative purposes only, and are not to scale. The plan and any matters shown on or inferred from it do not give rise to a legally binding obligation on or representation or warranty by Legacy Property. Legacy Property accepts no liability for any loss or damage arising as a result of any reliance on this plan or its contents. Rouse Hill Heights is located in the suburb of Box Hill NSW 2765.



ROAD No. 7 (18.0 WIDE)

10/03/21

LEGEND

-  SEWER MAIN & ACCESS POINT
-  STORMWATER & PITS
-  DESIGN CONTOUR & LEVEL
-  Max. 1m RETAINING WALL

- (A) EASEMENT FOR DRAINAGE 1.5 WIDE
- (B) EASEMENT FOR MAINTENANCE & REPAIRS 0.9 WIDE

NOTE:
ALL CONTOURS HAVE INTERVAL OF 0.5m
(Contours are approximate only)

* AREA SUBJECT TO FINAL SURVEY
* BEARING AND DISTANCES SUBJECT TO FINAL SURVEY



 Sales Centre:
285 Annangrove Road, Rouse Hill



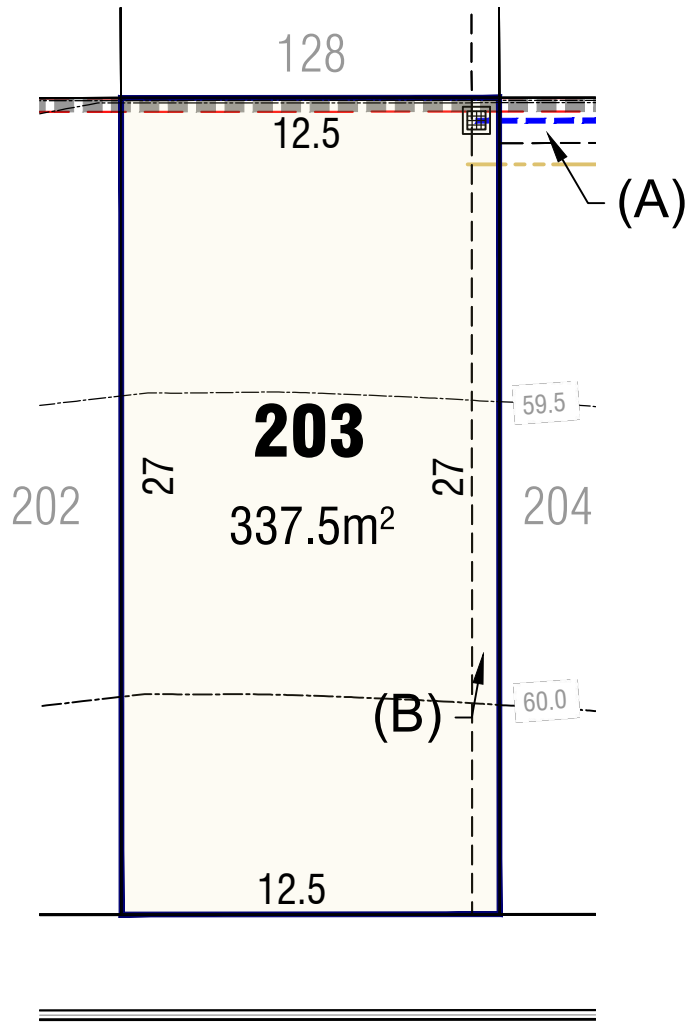

rousehillheights.com.au



ROAD No. 7 (18.0 WIDE)

10/03/21

LEGEND

-  SEWER MAIN & ACCESS POINT
-  STORMWATER & PITS
-  50.0 DESIGN CONTOUR & LEVEL
-  Max. 1m RETAINING WALL

- (A) EASEMENT FOR DRAINAGE 1.5 WIDE
- (B) EASEMENT FOR MAINTENANCE & REPAIRS 0.9 WIDE

NOTE:
ALL CONTOURS HAVE INTERVAL OF 0.5m
(Contours are approximate only)

* AREA SUBJECT TO FINAL SURVEY
* BEARING AND DISTANCES SUBJECT TO FINAL SURVEY



 Sales Centre:
285 Annangrove Road, Rouse Hill

rousehillheights.com.au



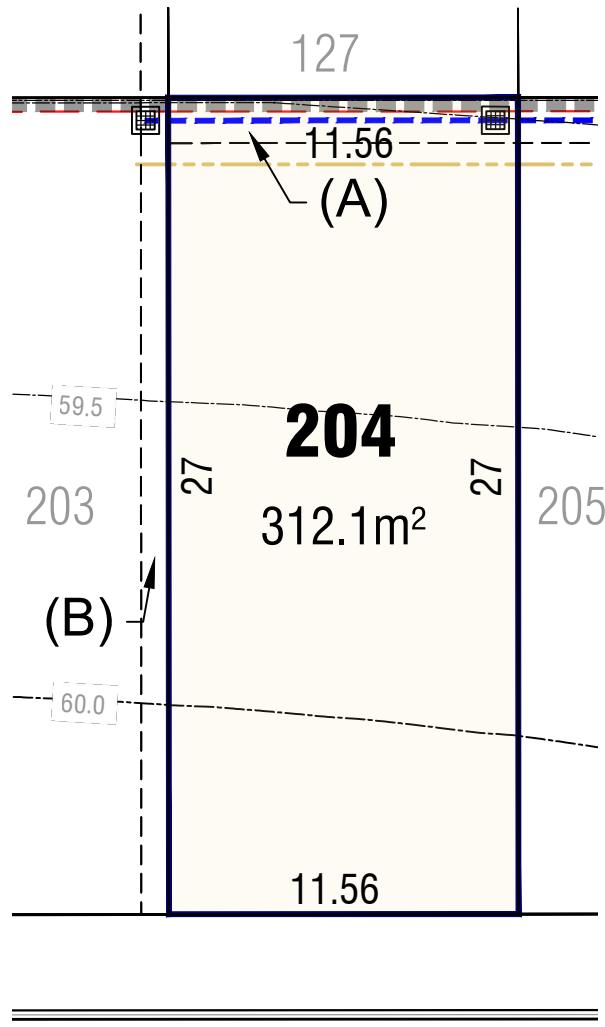

This plan is provided solely for the purpose of providing an impression of the concept relating to the proposed development called 'Rouse Hill Heights', as well as the approximate location of existing and proposed third party facilities, services or destinations and is not intended to be used for any other purpose. Legacy Property does not make any representations or give any warranty in relation to the future development of the site, the staging of any future development or the current or future location or existence of any facilities, services or destinations. The plan is based on the present intention of, and information available to, Legacy Property and the current known requirements of relevant authorities at the time of creation of the plan and details may change due to future circumstances. Any indications of distance or size are approximate and for indicative purposes only, and are not to scale. The plan and any matters shown on or inferred from it do not give rise to a legally binding obligation on or representation or warranty by Legacy Property. Legacy Property accepts no liability for any loss or damage arising as a result of any reliance on this plan or its contents. Rouse Hill Heights is located in the suburb of Box Hill NSW 2765.



ROAD No. 7 (18.0 WIDE)

10/03/21

LEGEND

-  SEWER MAIN & ACCESS POINT
-  STORMWATER & PITS
-  50.0 DESIGN CONTOUR & LEVEL
-  Max. 1m RETAINING WALL

- (A) EASEMENT FOR DRAINAGE 1.5 WIDE
- (B) EASEMENT FOR MAINTENANCE & REPAIRS 0.9 WIDE

NOTE:
ALL CONTOURS HAVE INTERVAL OF 0.5m
(Contours are approximate only)

* AREA SUBJECT TO FINAL SURVEY
* BEARING AND DISTANCES SUBJECT TO FINAL SURVEY





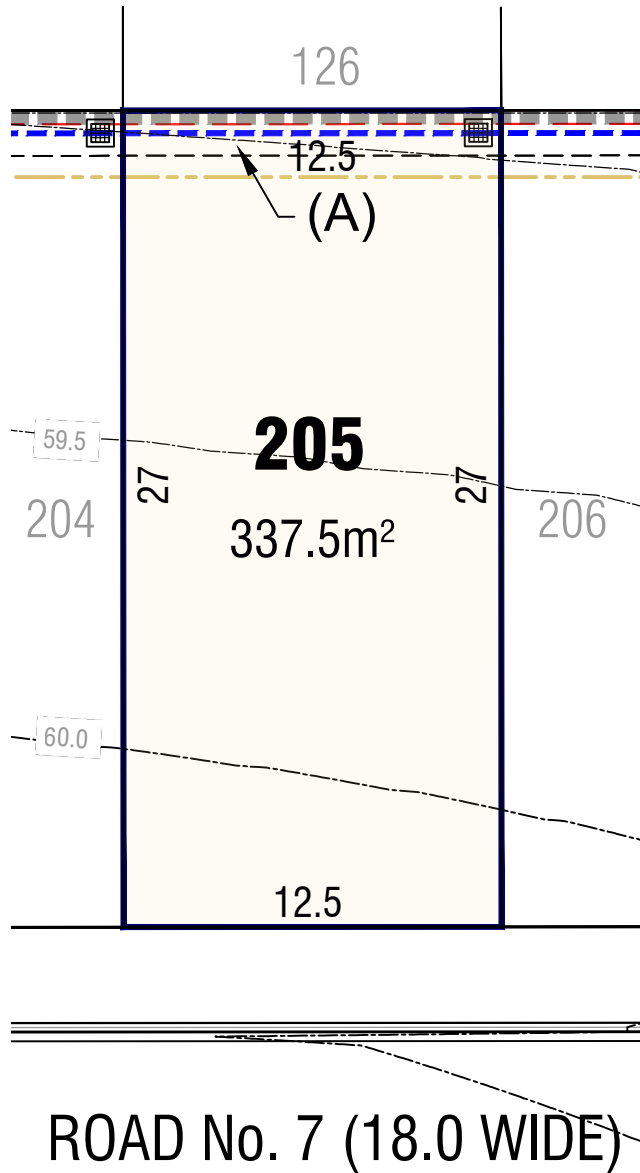

 Sales Centre:
285 Annangrove Road, Rouse Hill

rousehillheights.com.au



10/03/21

LEGEND

-  SEWER MAIN & ACCESS POINT
-  STORMWATER & PITS
-  DESIGN CONTOUR & LEVEL
-  Max. 1m RETAINING WALL

- (A) EASEMENT FOR DRAINAGE 1.5 WIDE
- (B) EASEMENT FOR MAINTENANCE & REPAIRS 0.9 WIDE

NOTE:
ALL CONTOURS HAVE INTERVAL OF 0.5m
(Contours are approximate only)

* AREA SUBJECT TO FINAL SURVEY
* BEARING AND DISTANCES SUBJECT TO FINAL SURVEY





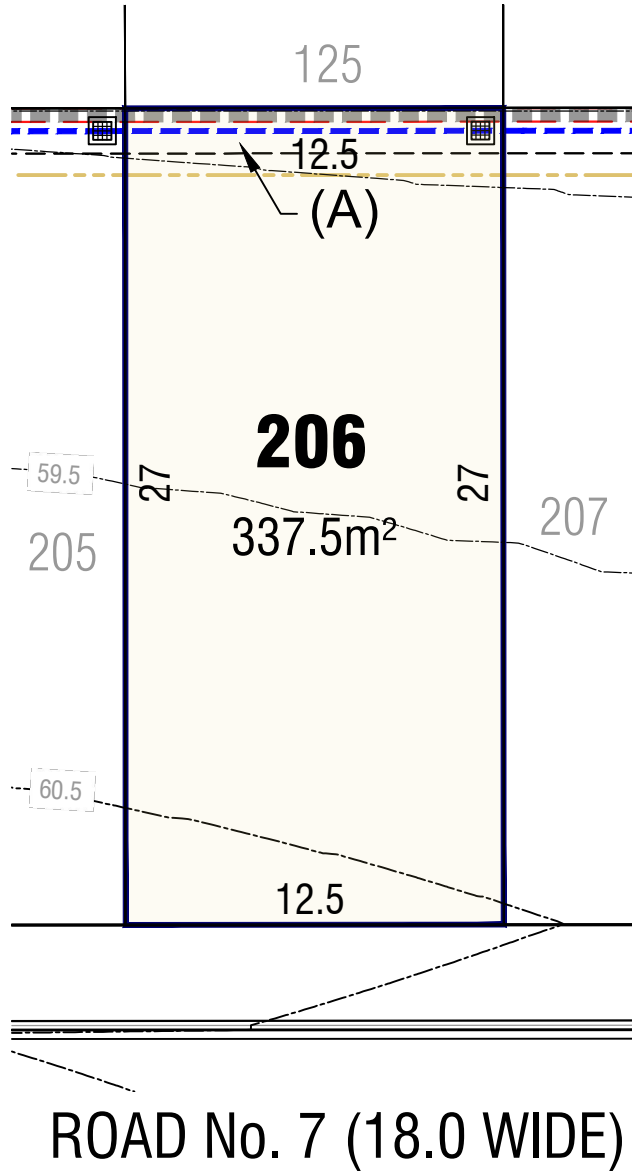

 Sales Centre:
285 Annangrove Road, Rouse Hill

rousehillheights.com.au



10/03/21

LEGEND

-  SEWER MAIN & ACCESS POINT
-  STORMWATER & PITS
-  50.0 DESIGN CONTOUR & LEVEL
-  Max. 1m RETAINING WALL

- (A) EASEMENT FOR DRAINAGE 1.5 WIDE
- (B) EASEMENT FOR MAINTENANCE & REPAIRS 0.9 WIDE

NOTE:
ALL CONTOURS HAVE INTERVAL OF 0.5m
(Contours are approximate only)

* AREA SUBJECT TO FINAL SURVEY
* BEARING AND DISTANCES SUBJECT TO FINAL SURVEY



 Sales Centre:
285 Annangrove Road, Rouse Hill



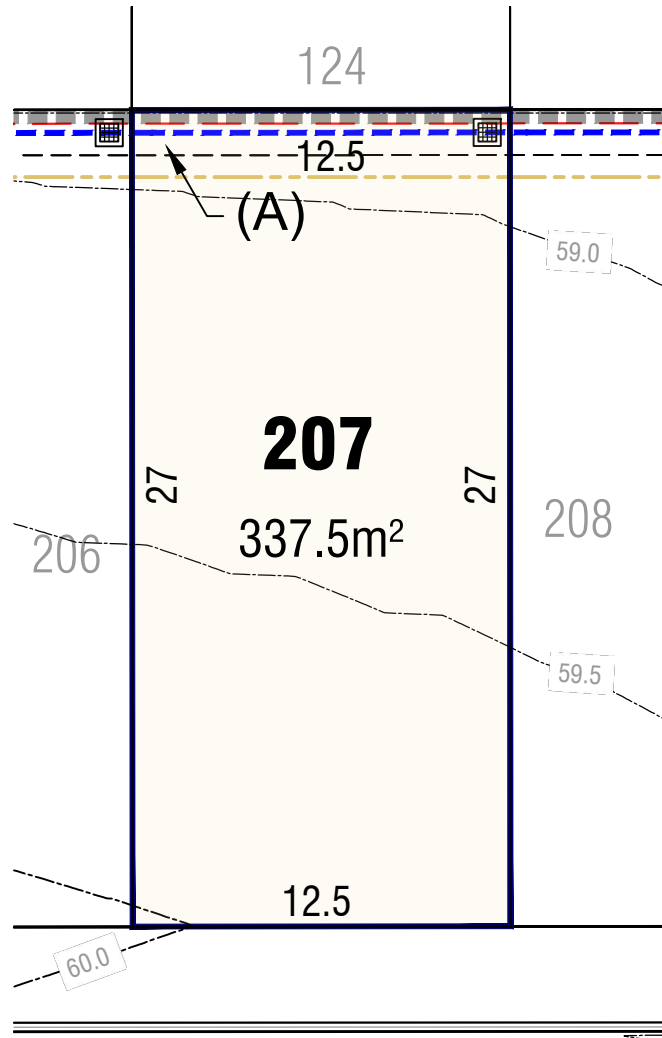

rousehillheights.com.au



ROAD No. 7 (18.0 WIDE)

10/03/21

LEGEND

-  SEWER MAIN & ACCESS POINT
-  STORMWATER & PITS
-  50.0 DESIGN CONTOUR & LEVEL
-  Max. 1m RETAINING WALL

- (A) EASEMENT FOR DRAINAGE 1.5 WIDE
- (B) EASEMENT FOR MAINTENANCE & REPAIRS 0.9 WIDE

NOTE:
ALL CONTOURS HAVE INTERVAL OF 0.5m
(Contours are approximate only)

* AREA SUBJECT TO FINAL SURVEY
* BEARING AND DISTANCES SUBJECT TO FINAL SURVEY



 Sales Centre:
285 Annangrove Road, Rouse Hill

rousehillheights.com.au



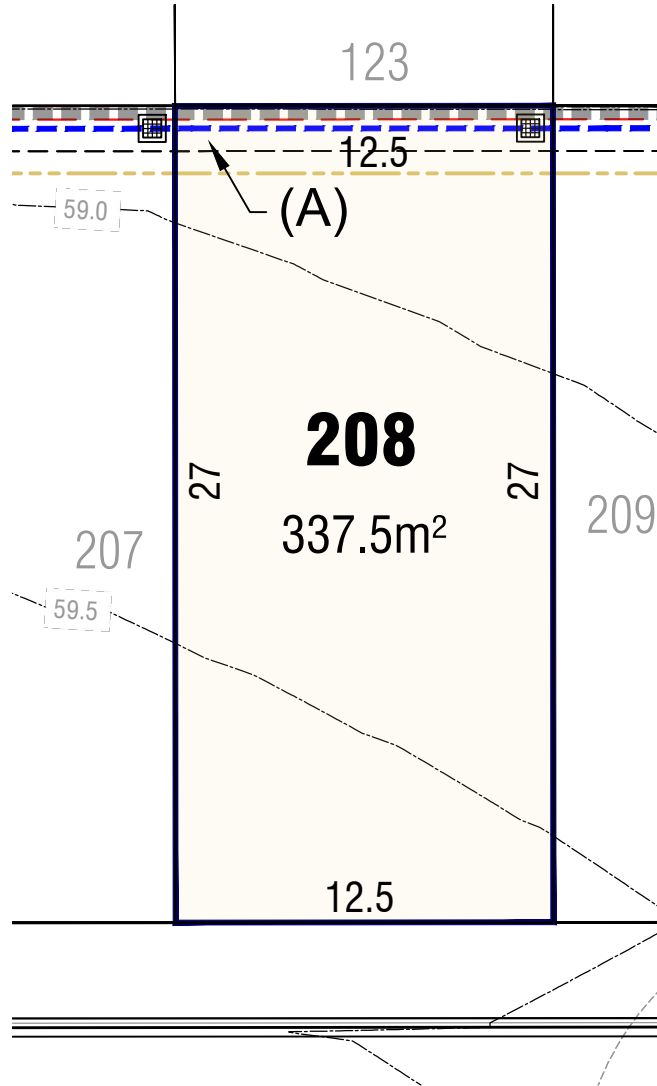

This plan is provided solely for the purpose of providing an impression of the concept relating to the proposed development called 'Rouse Hill Heights', as well as the approximate location of existing and proposed third party facilities, services or destinations and is not intended to be used for any other purpose. Legacy Property does not make any representations or give any warranty in relation to the future development of the site, the staging of any future development or the current or future location or existence of any facilities, services or destinations. The plan is based on the present intention of, and information available to, Legacy Property and the current known requirements of relevant authorities at the time of creation of the plan and details may change due to future circumstances. Any indications of distance or size are approximate and for indicative purposes only, and are not to scale. The plan and any matters shown on or inferred from it do not give rise to a legally binding obligation on or representation or warranty by Legacy Property. Legacy Property accepts no liability for any loss or damage arising as a result of any reliance on this plan or its contents. Rouse Hill Heights is located in the suburb of Box Hill NSW 2765.



ROAD No. 7 (18.0 WIDE)

10/03/21

LEGEND

-  SEWER MAIN & ACCESS POINT
-  STORMWATER & PITS
-  DESIGN CONTOUR & LEVEL
-  Max. 1m RETAINING WALL

- (A) EASEMENT FOR DRAINAGE 1.5 WIDE
- (B) EASEMENT FOR MAINTENANCE & REPAIRS 0.9 WIDE

NOTE:
ALL CONTOURS HAVE INTERVAL OF 0.5m
(Contours are approximate only)

* AREA SUBJECT TO FINAL SURVEY
* BEARING AND DISTANCES SUBJECT TO FINAL SURVEY



 Sales Centre:
285 Annangrove Road, Rouse Hill

rousehillheights.com.au



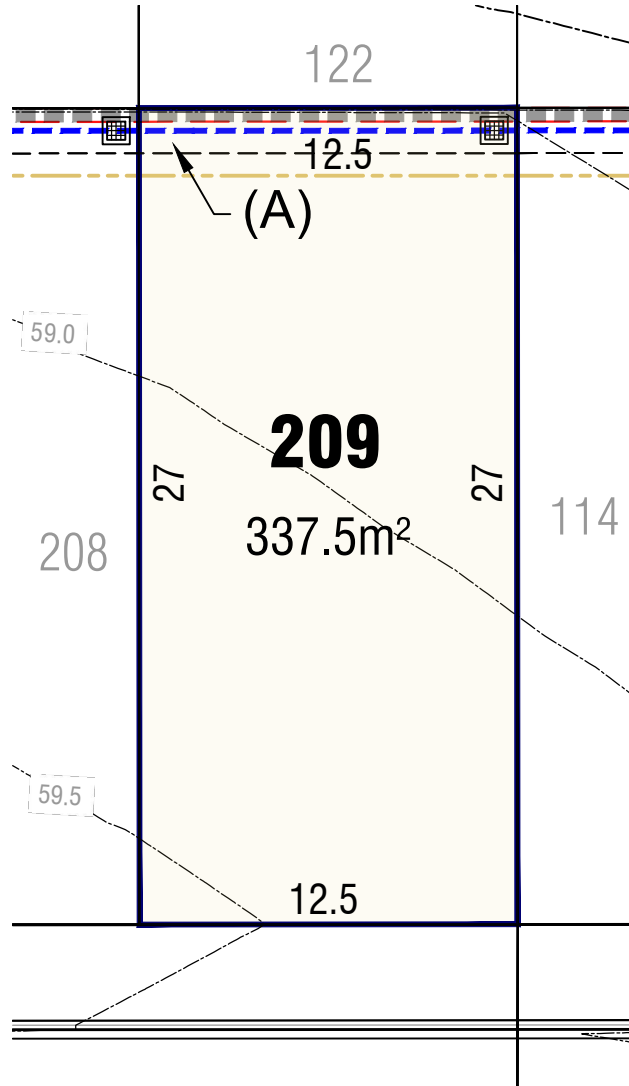

This plan is provided solely for the purpose of providing an impression of the concept relating to the proposed development called 'Rouse Hill Heights', as well as the approximate location of existing and proposed third party facilities, services or destinations and is not intended to be used for any other purpose. Legacy Property does not make any representations or give any warranty in relation to the future development of the site, the staging of any future development or the current or future location or existence of any facilities, services or destinations. The plan is based on the present intention of, and information available to, Legacy Property and the current known requirements of relevant authorities at the time of creation of the plan and details may change due to future circumstances. Any indications of distance or size are approximate and for indicative purposes only, and are not to scale. The plan and any matters shown on or inferred from it do not give rise to a legally binding obligation on or representation or warranty by Legacy Property. Legacy Property accepts no liability for any loss or damage arising as a result of any reliance on this plan or its contents. Rouse Hill Heights is located in the suburb of Box Hill NSW 2765.



ROAD No. 7 (18.0 WIDE)

10/03/21

LEGEND

-  SEWER MAIN & ACCESS POINT
-  STORMWATER & PITS
-  50.0 DESIGN CONTOUR & LEVEL
-  Max. 1m RETAINING WALL

- (A) EASEMENT FOR DRAINAGE 1.5 WIDE
- (B) EASEMENT FOR MAINTENANCE & REPAIRS 0.9 WIDE

NOTE:
ALL CONTOURS HAVE INTERVAL OF 0.5m
(Contours are approximate only)

* AREA SUBJECT TO FINAL SURVEY
* BEARING AND DISTANCES SUBJECT TO FINAL SURVEY





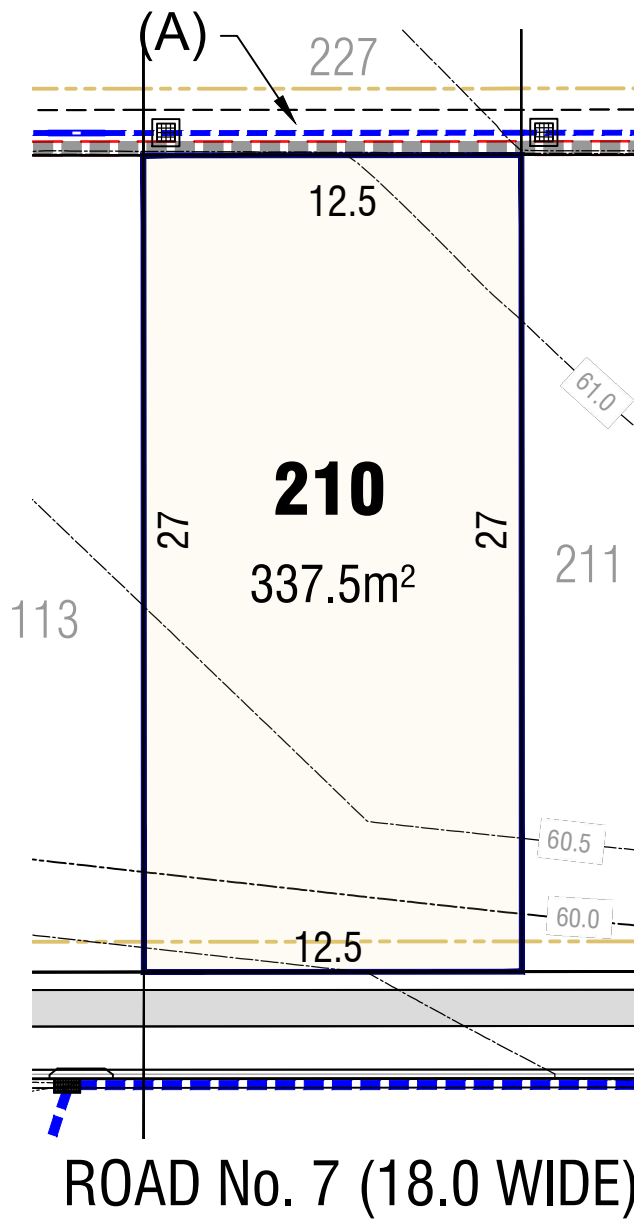

 Sales Centre:
285 Annangrove Road, Rouse Hill

rousehillheights.com.au



10/03/21

LEGEND

-  SEWER MAIN & ACCESS POINT
-  STORMWATER & PITS
-  50.0 DESIGN CONTOUR & LEVEL
-  Max. 1m RETAINING WALL

- (A) EASEMENT FOR DRAINAGE 1.5 WIDE
- (B) EASEMENT FOR MAINTENANCE & REPAIRS 0.9 WIDE

NOTE:
ALL CONTOURS HAVE INTERVAL OF 0.5m
(Contours are approximate only)

* AREA SUBJECT TO FINAL SURVEY
* BEARING AND DISTANCES SUBJECT TO FINAL SURVEY



 Sales Centre:
285 Annangrove Road, Rouse Hill





rousehillheights.com.au

This plan is provided solely for the purpose of providing an impression of the concept relating to the proposed development called 'Rouse Hill Heights', as well as the approximate location of existing and proposed third party facilities, services or destinations and is not intended to be used for any other purpose. Legacy Property does not make any representations or give any warranty in relation to the future development of the site, the staging of any future development or the current or future location or existence of any facilities, services or destinations. The plan is based on the present intention of, and information available to, Legacy Property and the current known requirements of relevant authorities at the time of creation of the plan and details may change due to future circumstances. Any indications of distance or size are approximate and for indicative purposes only, and are not to scale. The plan and any matters shown on or inferred from it do not give rise to a legally binding obligation on or representation or warranty by Legacy Property. Legacy Property accepts no liability for any loss or damage arising as a result of any reliance on this plan or its contents. Rouse Hill Heights is located in the suburb of Box Hill NSW 2765.



10/03/21

LEGEND

-  SEWER MAIN & ACCESS POINT
-  STORMWATER & PITS
-  DESIGN CONTOUR & LEVEL
-  Max. 1m RETAINING WALL

- (A) EASEMENT FOR DRAINAGE 1.5 WIDE
- (B) EASEMENT FOR MAINTENANCE & REPAIRS 0.9 WIDE

NOTE:
ALL CONTOURS HAVE INTERVAL OF 0.5m
(Contours are approximate only)

* AREA SUBJECT TO FINAL SURVEY
* BEARING AND DISTANCES SUBJECT TO FINAL SURVEY



R Sales Centre:
285 Annangrove Road, Rouse Hill

rousehillheights.com.au



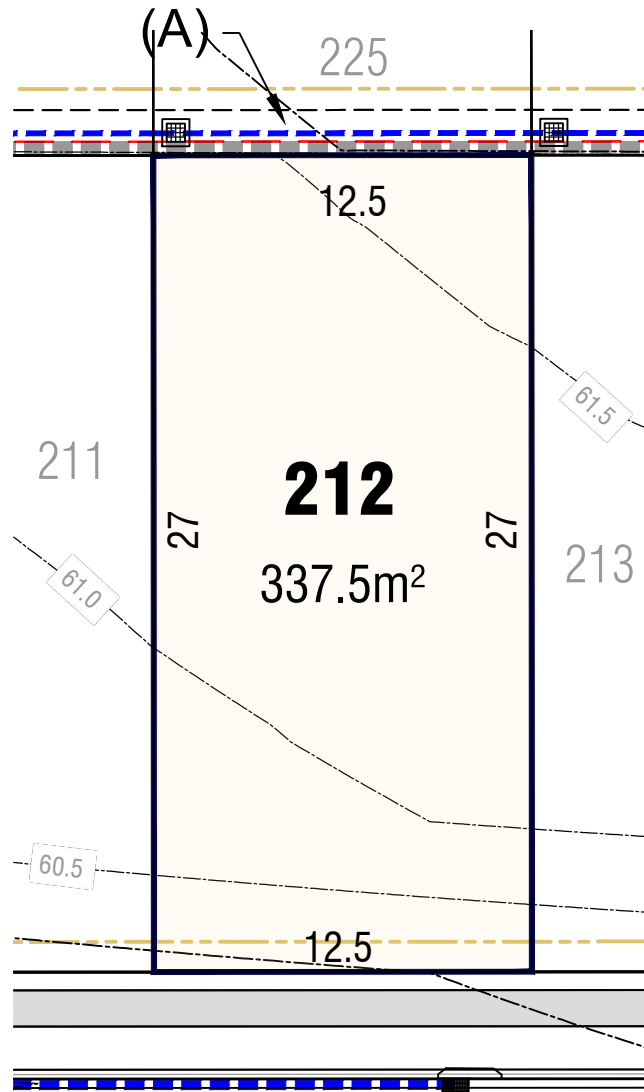

This plan is provided solely for the purpose of providing an impression of the concept relating to the proposed development called 'Rouse Hill Heights', as well as the approximate location of existing and proposed third party facilities, services or destinations and is not intended to be used for any other purpose. Legacy Property does not make any representations or give any warranty in relation to the future development of the site, the staging of any future development or the current or future location or existence of any facilities, services or destinations. The plan is based on the present intention of, and information available to, Legacy Property and the current known requirements of relevant authorities at the time of creation of the plan and details may change due to future circumstances. Any indications of distance or size are approximate and for indicative purposes only, and are not to scale. The plan and any matters shown on or inferred from it do not give rise to a legally binding obligation on or representation or warranty by Legacy Property. Legacy Property accepts no liability for any loss or damage arising as a result of any reliance on this plan or its contents. Rouse Hill Heights is located in the suburb of Box Hill NSW 2765.



ROAD No. 7 (18.0 WIDE)

10/03/21

LEGEND

-  SEWER MAIN & ACCESS POINT
-  STORMWATER & PITS
-  DESIGN CONTOUR & LEVEL
-  Max. 1m RETAINING WALL

- (A) EASEMENT FOR DRAINAGE 1.5 WIDE
- (B) EASEMENT FOR MAINTENANCE & REPAIRS 0.9 WIDE

NOTE:
ALL CONTOURS HAVE INTERVAL OF 0.5m
(Contours are approximate only)

* AREA SUBJECT TO FINAL SURVEY
* BEARING AND DISTANCES SUBJECT TO FINAL SURVEY



 Sales Centre:
285 Annangrove Road, Rouse Hill

rousehillheights.com.au



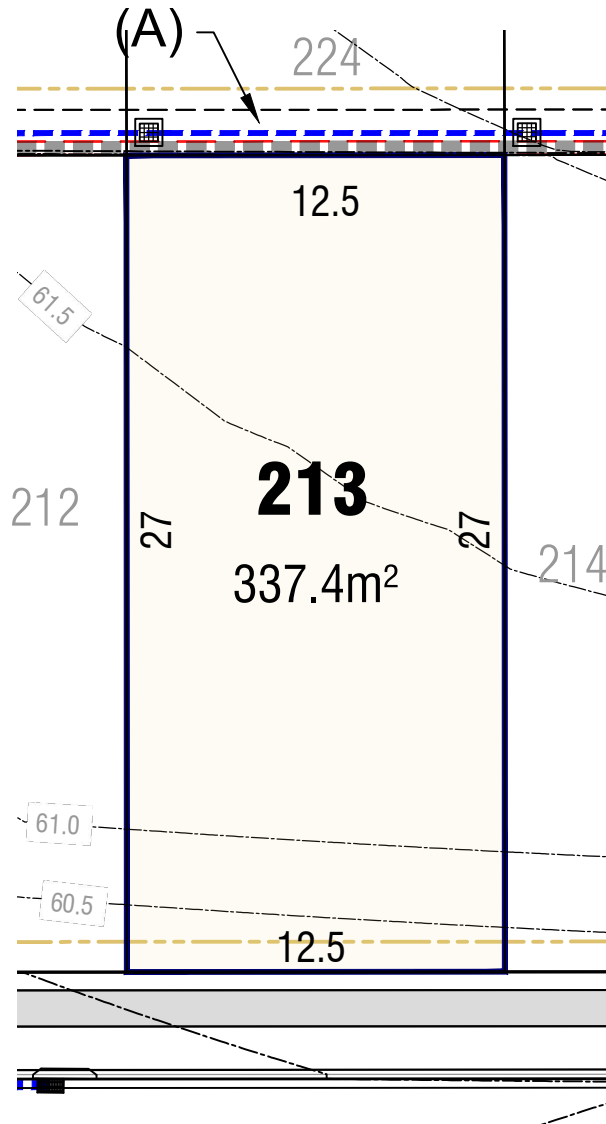

This plan is provided solely for the purpose of providing an impression of the concept relating to the proposed development called 'Rouse Hill Heights', as well as the approximate location of existing and proposed third party facilities, services or destinations and is not intended to be used for any other purpose. Legacy Property does not make any representations or give any warranty in relation to the future development of the site, the staging of any future development or the current or future location or existence of any facilities, services or destinations. The plan is based on the present intention of, and information available to, Legacy Property and the current known requirements of relevant authorities at the time of creation of the plan and details may change due to future circumstances. Any indications of distance or size are approximate and for indicative purposes only, and are not to scale. The plan and any matters shown on or inferred from it do not give rise to a legally binding obligation on or representation or warranty by Legacy Property. Legacy Property accepts no liability for any loss or damage arising as a result of any reliance on this plan or its contents. Rouse Hill Heights is located in the suburb of Box Hill NSW 2765.



ROAD No. 7 (18.0 WIDE)

10/03/21

LEGEND

-  SEWER MAIN & ACCESS POINT
-  STORMWATER & PITS
-  50.0 DESIGN CONTOUR & LEVEL
-  Max. 1m RETAINING WALL

- (A) EASEMENT FOR DRAINAGE 1.5 WIDE
- (B) EASEMENT FOR MAINTENANCE & REPAIRS 0.9 WIDE

NOTE:
ALL CONTOURS HAVE INTERVAL OF 0.5m
(Contours are approximate only)

* AREA SUBJECT TO FINAL SURVEY
* BEARING AND DISTANCES SUBJECT TO FINAL SURVEY



 Sales Centre:
285 Annangrove Road, Rouse Hill

rousehillheights.com.au



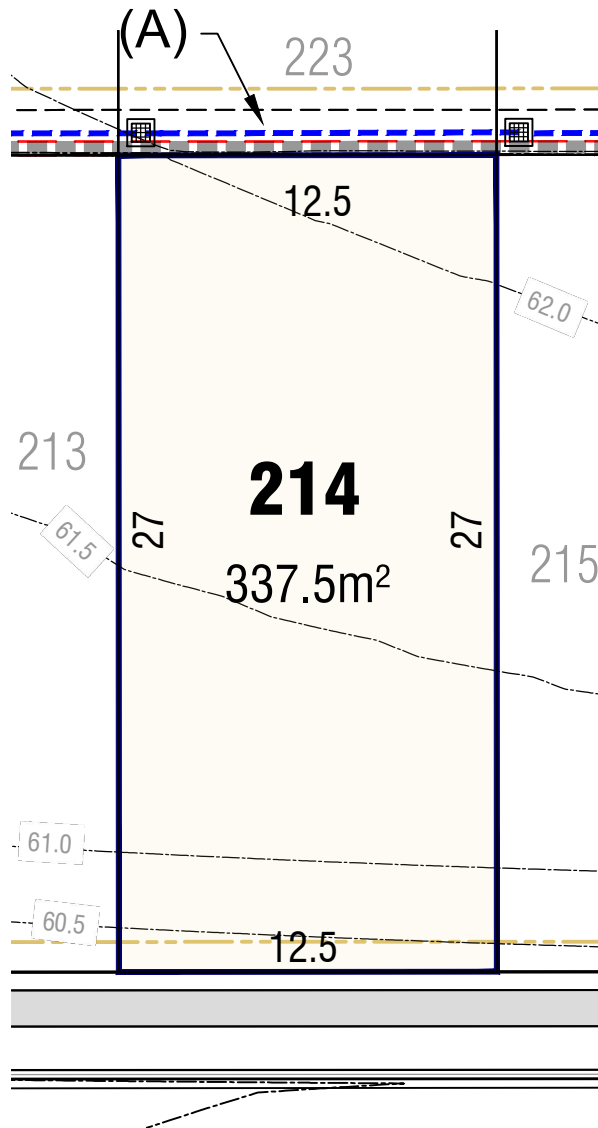

This plan is provided solely for the purpose of providing an impression of the concept relating to the proposed development called 'Rouse Hill Heights', as well as the approximate location of existing and proposed third party facilities, services or destinations and is not intended to be used for any other purpose. Legacy Property does not make any representations or give any warranty in relation to the future development of the site, the staging of any future development or the current or future location or existence of any facilities, services or destinations. The plan is based on the present intention of, and information available to, Legacy Property and the current known requirements of relevant authorities at the time of creation of the plan and details may change due to future circumstances. Any indications of distance or size are approximate and for indicative purposes only, and are not to scale. The plan and any matters shown on or inferred from it do not give rise to a legally binding obligation on or representation or warranty by Legacy Property. Legacy Property accepts no liability for any loss or damage arising as a result of any reliance on this plan or its contents. Rouse Hill Heights is located in the suburb of Box Hill NSW 2765.



ROAD No. 7 (18.0 WIDE)

10/03/21

LEGEND

-  SEWER MAIN & ACCESS POINT
-  STORMWATER & PITS
-  50.0 DESIGN CONTOUR & LEVEL
-  Max. 1m RETAINING WALL

- (A) EASEMENT FOR DRAINAGE 1.5 WIDE
- (B) EASEMENT FOR MAINTENANCE & REPAIRS 0.9 WIDE

NOTE:
ALL CONTOURS HAVE INTERVAL OF 0.5m
(Contours are approximate only)

* AREA SUBJECT TO FINAL SURVEY
* BEARING AND DISTANCES SUBJECT TO FINAL SURVEY



 Sales Centre:
285 Annangrove Road, Rouse Hill



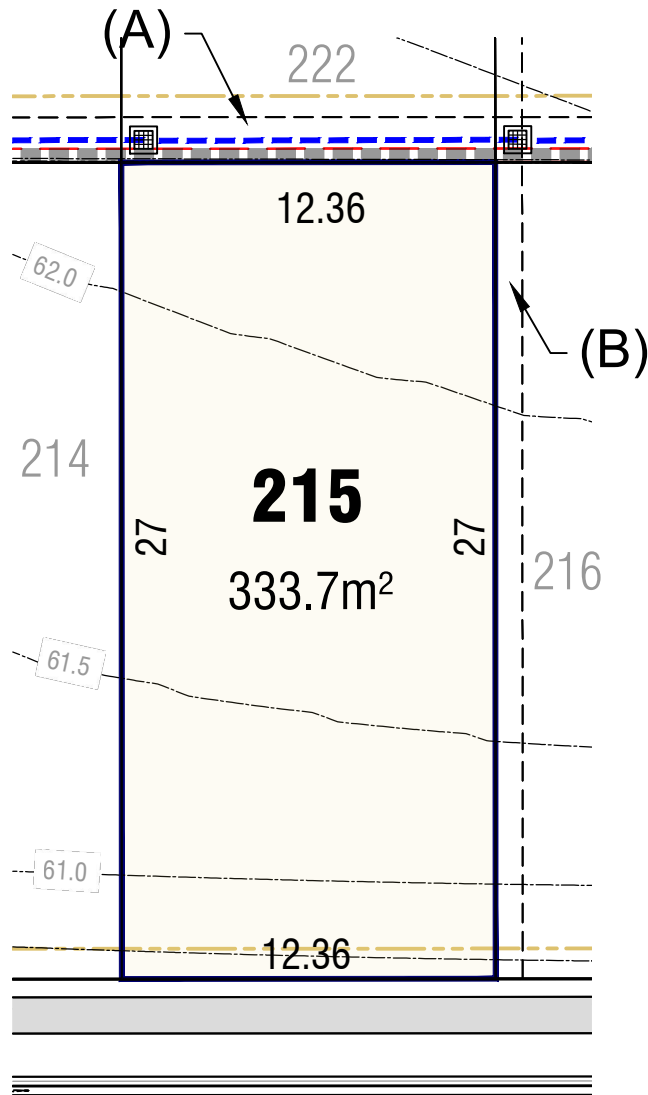

rousehillheights.com.au



ROAD No. 7 (18.0 WIDE)

10/03/21

LEGEND

-  SEWER MAIN & ACCESS POINT
-  STORMWATER & PITS
-  50.0 DESIGN CONTOUR & LEVEL
-  Max. 1m RETAINING WALL

- (A) EASEMENT FOR DRAINAGE 1.5 WIDE
- (B) EASEMENT FOR MAINTENANCE & REPAIRS 0.9 WIDE

NOTE:
ALL CONTOURS HAVE INTERVAL OF 0.5m
(Contours are approximate only)

* AREA SUBJECT TO FINAL SURVEY
* BEARING AND DISTANCES SUBJECT TO FINAL SURVEY



 Sales Centre:
285 Annangrove Road, Rouse Hill

rousehillheights.com.au



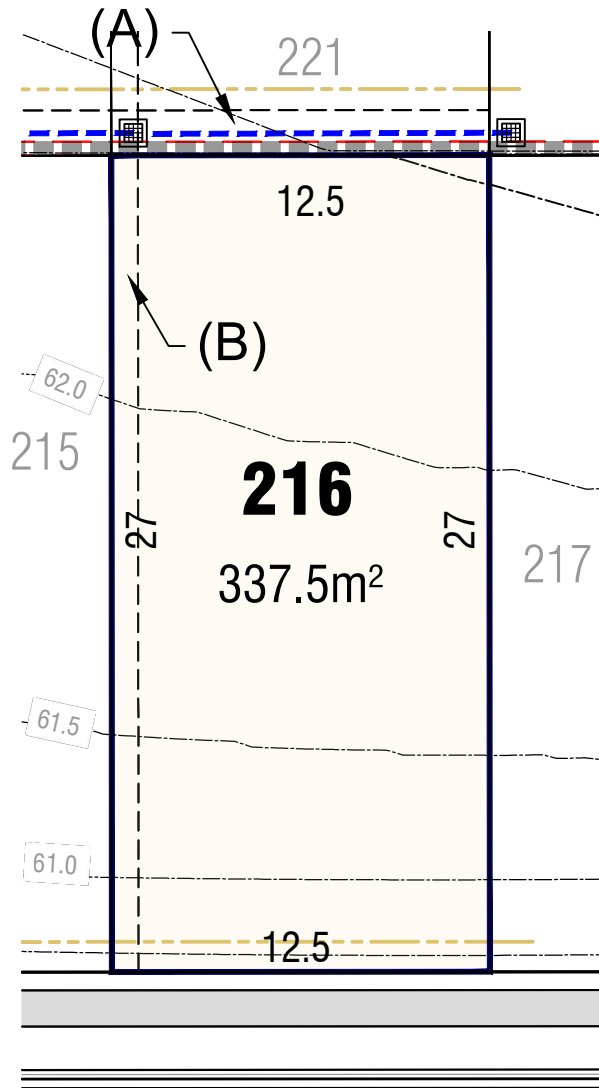

This plan is provided solely for the purpose of providing an impression of the concept relating to the proposed development called 'Rouse Hill Heights', as well as the approximate location of existing and proposed third party facilities, services or destinations and is not intended to be used for any other purpose. Legacy Property does not make any representations or give any warranty in relation to the future development of the site, the staging of any future development or the current or future location or existence of any facilities, services or destinations. The plan is based on the present intention of, and information available to, Legacy Property and the current known requirements of relevant authorities at the time of creation of the plan and details may change due to future circumstances. Any indications of distance or size are approximate and for indicative purposes only, and are not to scale. The plan and any matters shown on or inferred from it do not give rise to a legally binding obligation on or representation or warranty by Legacy Property. Legacy Property accepts no liability for any loss or damage arising as a result of any reliance on this plan or its contents. Rouse Hill Heights is located in the suburb of Box Hill NSW 2765.



ROAD No. 7 (18.0 WIDE)

10/03/21

LEGEND

-  SEWER MAIN & ACCESS POINT
-  STORMWATER & PITS
-  50.0 DESIGN CONTOUR & LEVEL
-  Max. 1m RETAINING WALL

- (A) EASEMENT FOR DRAINAGE 1.5 WIDE
- (B) EASEMENT FOR MAINTENANCE & REPAIRS 0.9 WIDE

NOTE:
ALL CONTOURS HAVE INTERVAL OF 0.5m
(Contours are approximate only)

* AREA SUBJECT TO FINAL SURVEY
* BEARING AND DISTANCES SUBJECT TO FINAL SURVEY



 Sales Centre:
285 Annangrove Road, Rouse Hill

rousehillheights.com.au



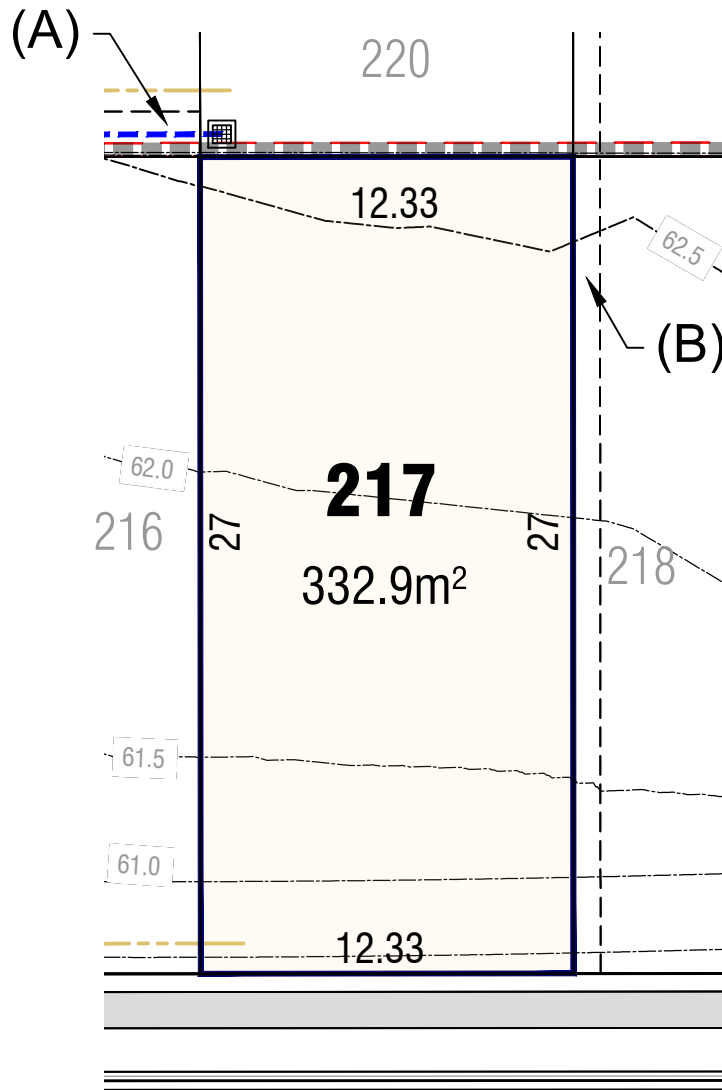

This plan is provided solely for the purpose of providing an impression of the concept relating to the proposed development called 'Rouse Hill Heights', as well as the approximate location of existing and proposed third party facilities, services or destinations and is not intended to be used for any other purpose. Legacy Property does not make any representations or give any warranty in relation to the future development of the site, the staging of any future development or the current or future location or existence of any facilities, services or destinations. The plan is based on the present intention of, and information available to, Legacy Property and the current known requirements of relevant authorities at the time of creation of the plan and details may change due to future circumstances. Any indications of distance or size are approximate and for indicative purposes only, and are not to scale. The plan and any matters shown on or inferred from it do not give rise to a legally binding obligation on or representation or warranty by Legacy Property. Legacy Property accepts no liability for any loss or damage arising as a result of any reliance on this plan or its contents. Rouse Hill Heights is located in the suburb of Box Hill NSW 2765.



ROAD No. 7 (18.0 WIDE)

10/03/21

LEGEND

-  SEWER MAIN & ACCESS POINT
-  STORMWATER & PITS
-  50.0 DESIGN CONTOUR & LEVEL
-  Max. 1m RETAINING WALL

- (A) EASEMENT FOR DRAINAGE 1.5 WIDE
- (B) EASEMENT FOR MAINTENANCE & REPAIRS 0.9 WIDE

NOTE:
ALL CONTOURS HAVE INTERVAL OF 0.5m
(Contours are approximate only)

* AREA SUBJECT TO FINAL SURVEY
* BEARING AND DISTANCES SUBJECT TO FINAL SURVEY



 Sales Centre:
285 Annangrove Road, Rouse Hill



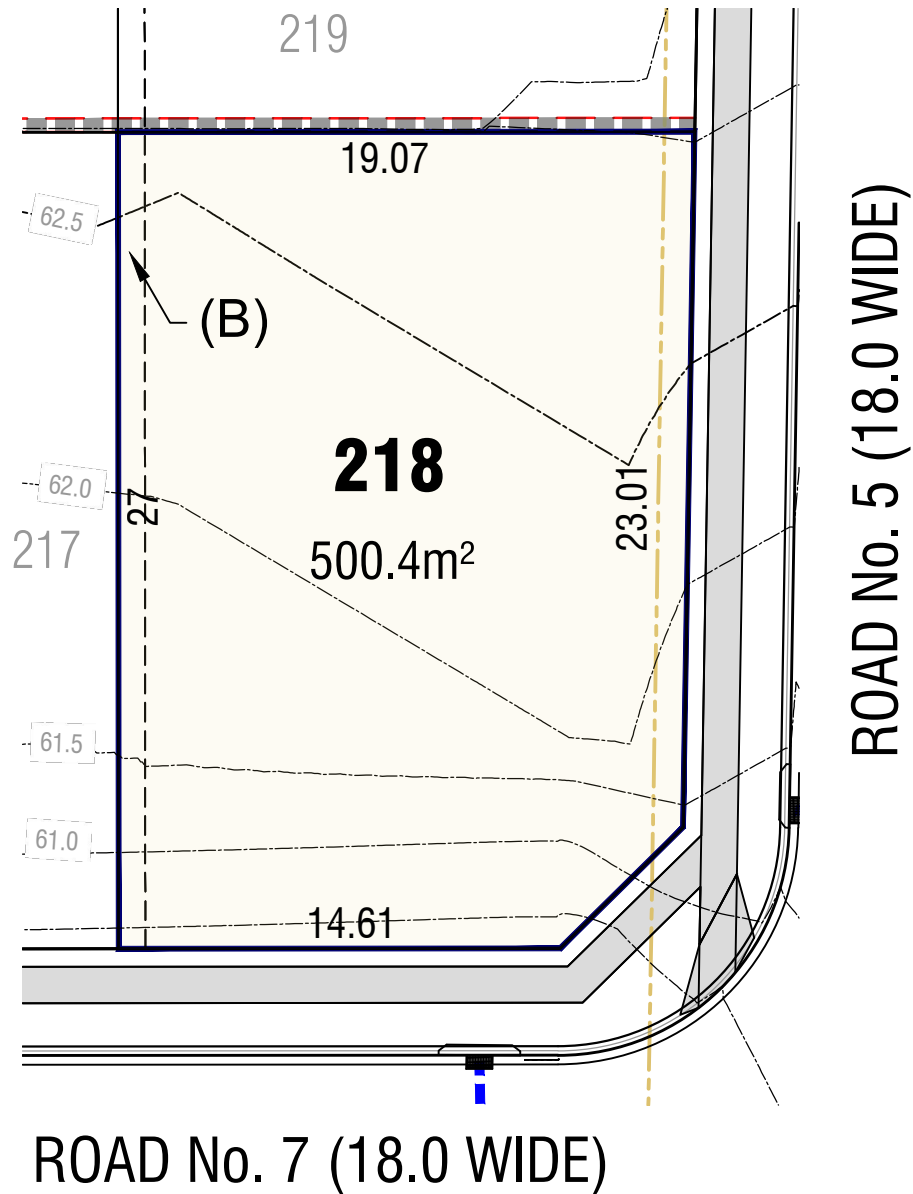

rousehillheights.com.au

This plan is provided solely for the purpose of providing an impression of the concept relating to the proposed development called 'Rouse Hill Heights', as well as the approximate location of existing and proposed third party facilities, services or destinations and is not intended to be used for any other purpose. Legacy Property does not make any representations or give any warranty in relation to the future development of the site, the staging of any future development or the current or future location or existence of any facilities, services or destinations. The plan is based on the present intention of, and information available to, Legacy Property and the current known requirements of relevant authorities at the time of creation of the plan and details may change due to future circumstances. Any indications of distance or size are approximate and for indicative purposes only, and are not to scale. The plan and any matters shown on or inferred from it do not give rise to a legally binding obligation on or representation or warranty by Legacy Property. Legacy Property accepts no liability for any loss or damage arising as a result of any reliance on this plan or its contents. Rouse Hill Heights is located in the suburb of Box Hill NSW 2765.



10/03/21

LEGEND

-  SEWER MAIN & ACCESS POINT
-  STORMWATER & PITS
-  50.0 DESIGN CONTOUR & LEVEL
-  Max. 1m RETAINING WALL

- (A) EASEMENT FOR DRAINAGE 1.5 WIDE
- (B) EASEMENT FOR MAINTENANCE & REPAIRS 0.9 WIDE

NOTE:
ALL CONTOURS HAVE INTERVAL OF 0.5m
(Contours are approximate only)

* AREA SUBJECT TO FINAL SURVEY
* BEARING AND DISTANCES SUBJECT TO FINAL SURVEY



A4
1:250





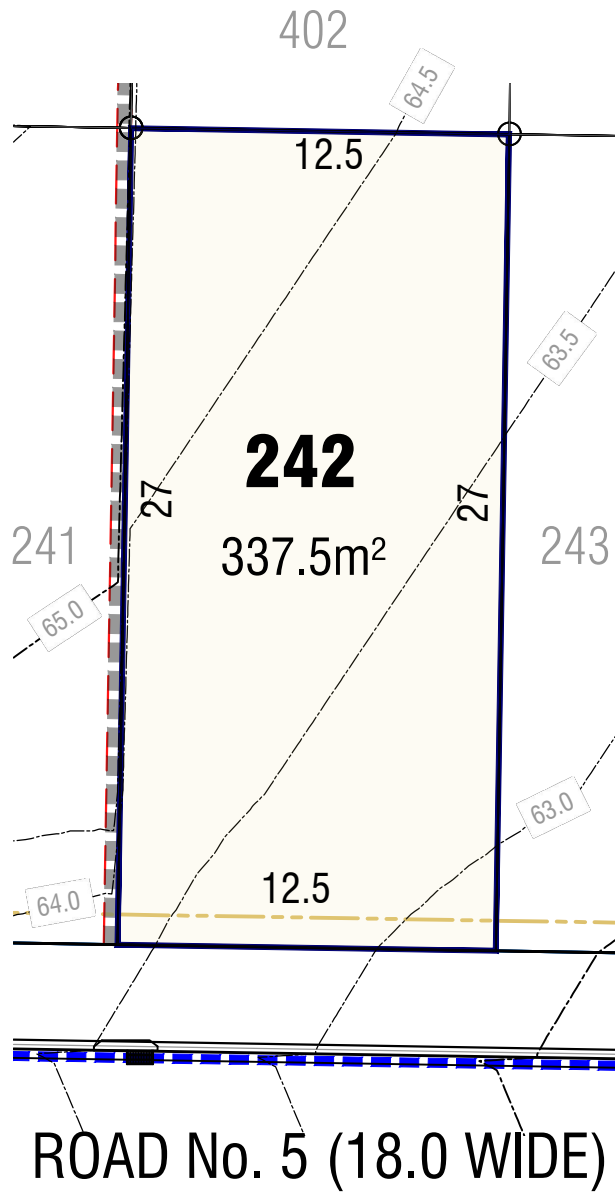

R Sales Centre:
285 Annangrove Road, Rouse Hill

rousehillheights.com.au



10/03/21

LEGEND

-  SEWER MAIN & ACCESS POINT
-  STORMWATER & PITS
-  DESIGN CONTOUR & LEVEL
-  Max. 1m RETAINING WALL

- (A) EASEMENT FOR DRAINAGE 1.5 WIDE
- (B) EASEMENT FOR MAINTENANCE & REPAIRS 0.9 WIDE

NOTE:
ALL CONTOURS HAVE INTERVAL OF 0.5m
(Contours are approximate only)

* AREA SUBJECT TO FINAL SURVEY
* BEARING AND DISTANCES SUBJECT TO FINAL SURVEY



R Sales Centre:
285 Annangrove Road, Rouse Hill



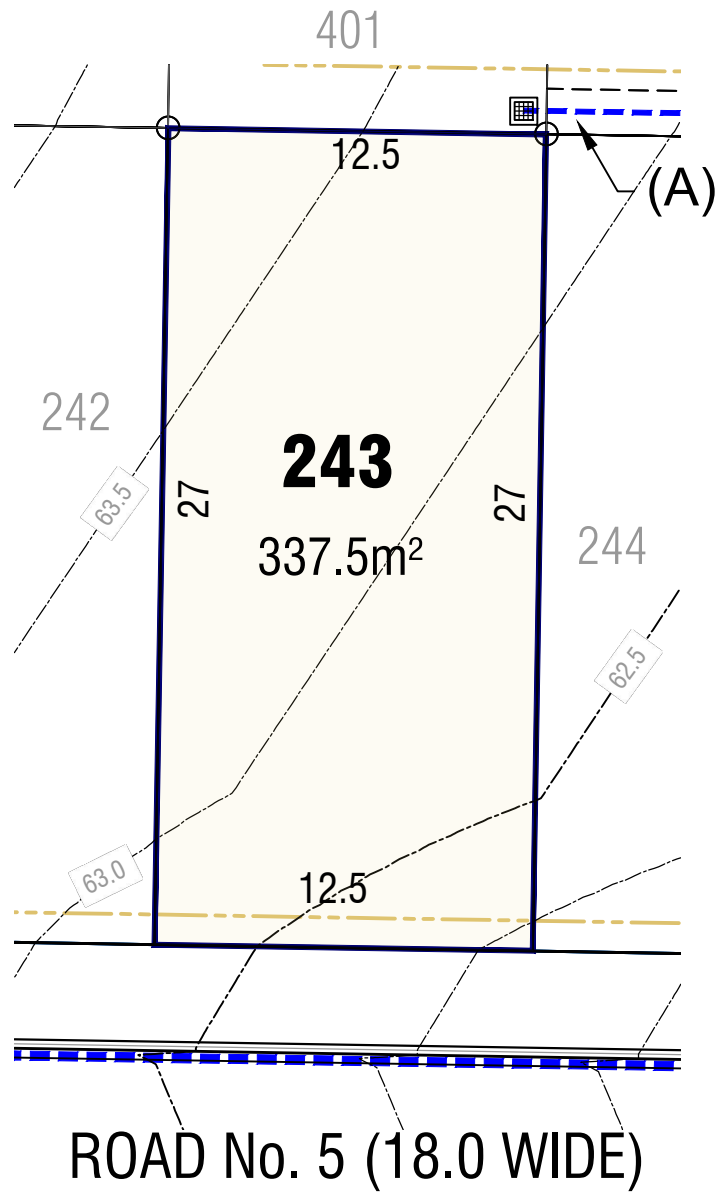

rousehillheights.com.au

This plan is provided solely for the purpose of providing an impression of the concept relating to the proposed development called 'Rouse Hill Heights', as well as the approximate location of existing and proposed third party facilities, services or destinations and is not intended to be used for any other purpose. Legacy Property does not make any representations or give any warranty in relation to the future development of the site, the staging of any future development or the current or future location or existence of any facilities, services or destinations. The plan is based on the present intention of, and information available to, Legacy Property and the current known requirements of relevant authorities at the time of creation of the plan and details may change due to future circumstances. Any indications of distance or size are approximate and for indicative purposes only, and are not to scale. The plan and any matters shown on or inferred from it do not give rise to a legally binding obligation on or representation or warranty by Legacy Property. Legacy Property accepts no liability for any loss or damage arising as a result of any reliance on this plan or its contents. Rouse Hill Heights is located in the suburb of Box Hill NSW 2765.



10/03/21

LEGEND

-  SEWER MAIN & ACCESS POINT
-  STORMWATER & PITS
-  50.0 DESIGN CONTOUR & LEVEL
-  Max. 1m RETAINING WALL

- (A) EASEMENT FOR DRAINAGE 1.5 WIDE
- (B) EASEMENT FOR MAINTENANCE & REPAIRS 0.9 WIDE

NOTE:
ALL CONTOURS HAVE INTERVAL OF 0.5m
(Contours are approximate only)

* AREA SUBJECT TO FINAL SURVEY
* BEARING AND DISTANCES SUBJECT TO FINAL SURVEY



R Sales Centre:
285 Annangrove Road, Rouse Hill



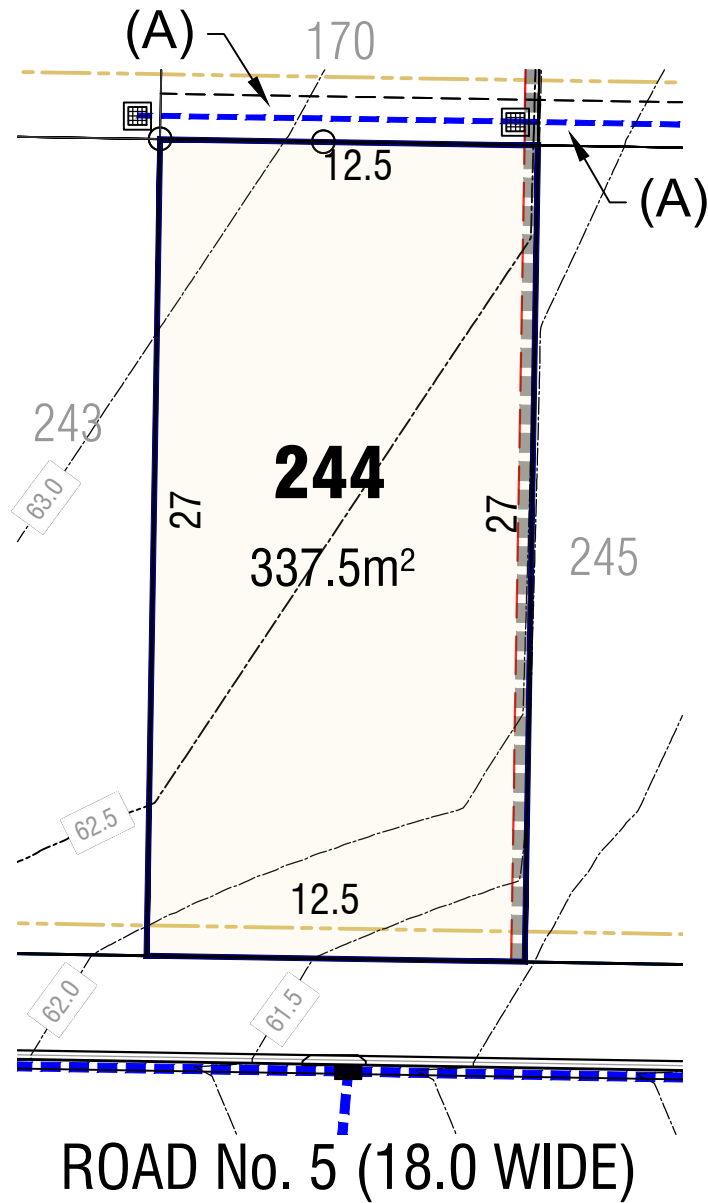

rousehillheights.com.au

This plan is provided solely for the purpose of providing an impression of the concept relating to the proposed development called 'Rouse Hill Heights', as well as the approximate location of existing and proposed third party facilities, services or destinations and is not intended to be used for any other purpose. Legacy Property does not make any representations or give any warranty in relation to the future development of the site, the staging of any future development or the current or future location or existence of any facilities, services or destinations. The plan is based on the present intention of, and information available to, Legacy Property and the current known requirements of relevant authorities at the time of creation of the plan and details may change due to future circumstances. Any indications of distance or size are approximate and for indicative purposes only, and are not to scale. The plan and any matters shown on or inferred from it do not give rise to a legally binding obligation on or representation or warranty by Legacy Property. Legacy Property accepts no liability for any loss or damage arising as a result of any reliance on this plan or its contents. Rouse Hill Heights is located in the suburb of Box Hill NSW 2765.



10/03/21

LEGEND

-  SEWER MAIN & ACCESS POINT
-  STORMWATER & PITS
-  DESIGN CONTOUR & LEVEL
-  Max. 1m RETAINING WALL

- (A) EASEMENT FOR DRAINAGE 1.5 WIDE
- (B) EASEMENT FOR MAINTENANCE & REPAIRS 0.9 WIDE

NOTE:
ALL CONTOURS HAVE INTERVAL OF 0.5m
(Contours are approximate only)

* AREA SUBJECT TO FINAL SURVEY
* BEARING AND DISTANCES SUBJECT TO FINAL SURVEY



R Sales Centre:
285 Annangrove Road, Rouse Hill



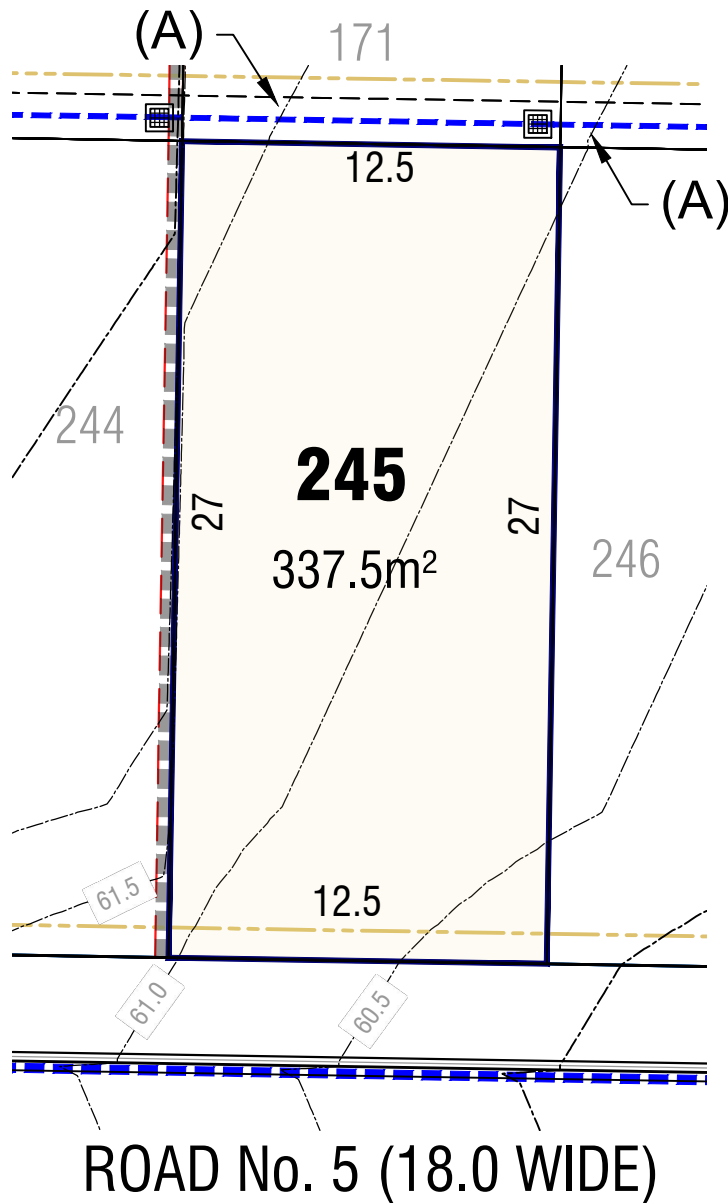

rousehillheights.com.au

This plan is provided solely for the purpose of providing an impression of the concept relating to the proposed development called 'Rouse Hill Heights', as well as the approximate location of existing and proposed third party facilities, services or destinations and is not intended to be used for any other purpose. Legacy Property does not make any representations or give any warranty in relation to the future development of the site, the staging of any future development or the current or future location or existence of any facilities, services or destinations. The plan is based on the present intention of, and information available to, Legacy Property and the current known requirements of relevant authorities at the time of creation of the plan and details may change due to future circumstances. Any indications of distance or size are approximate and for indicative purposes only, and are not to scale. The plan and any matters shown on or inferred from it do not give rise to a legally binding obligation on or representation or warranty by Legacy Property. Legacy Property accepts no liability for any loss or damage arising as a result of any reliance on this plan or its contents. Rouse Hill Heights is located in the suburb of Box Hill NSW 2765.



10/03/21

LEGEND

-  SEWER MAIN & ACCESS POINT
-  STORMWATER & PITS
-  50.0 DESIGN CONTOUR & LEVEL
-  Max. 1m RETAINING WALL

- (A) EASEMENT FOR DRAINAGE 1.5 WIDE
- (B) EASEMENT FOR MAINTENANCE & REPAIRS 0.9 WIDE

NOTE:
ALL CONTOURS HAVE INTERVAL OF 0.5m
(Contours are approximate only)

* AREA SUBJECT TO FINAL SURVEY
* BEARING AND DISTANCES SUBJECT TO FINAL SURVEY



R Sales Centre:
285 Annangrove Road, Rouse Hill



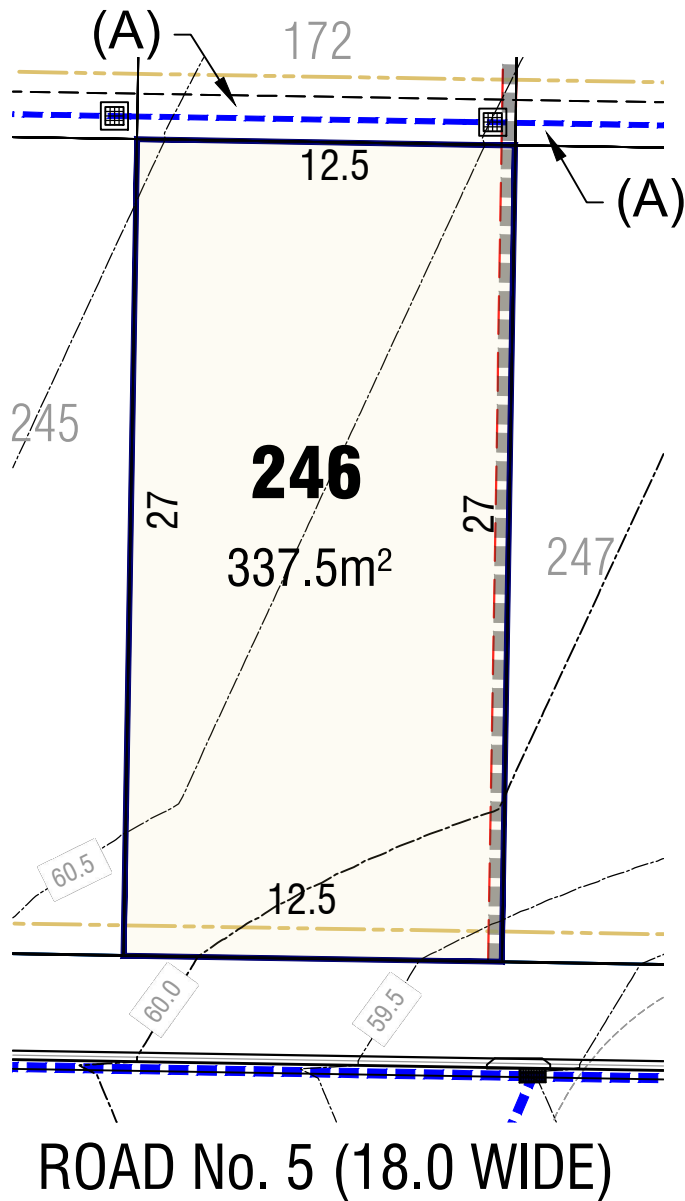

rousehillheights.com.au

This plan is provided solely for the purpose of providing an impression of the concept relating to the proposed development called 'Rouse Hill Heights', as well as the approximate location of existing and proposed third party facilities, services or destinations and is not intended to be used for any other purpose. Legacy Property does not make any representations or give any warranty in relation to the future development of the site, the staging of any future development or the current or future location or existence of any facilities, services or destinations. The plan is based on the present intention of, and information available to, Legacy Property and the current known requirements of relevant authorities at the time of creation of the plan and details may change due to future circumstances. Any indications of distance or size are approximate and for indicative purposes only, and are not to scale. The plan and any matters shown on or inferred from it do not give rise to a legally binding obligation on or representation or warranty by Legacy Property. Legacy Property accepts no liability for any loss or damage arising as a result of any reliance on this plan or its contents. Rouse Hill Heights is located in the suburb of Box Hill NSW 2765.



10/03/21

LEGEND

-  SEWER MAIN & ACCESS POINT
-  STORMWATER & PITS
-  50.0 DESIGN CONTOUR & LEVEL
-  Max. 1m RETAINING WALL

- (A) EASEMENT FOR DRAINAGE 1.5 WIDE
- (B) EASEMENT FOR MAINTENANCE & REPAIRS 0.9 WIDE

NOTE:
ALL CONTOURS HAVE INTERVAL OF 0.5m
(Contours are approximate only)

* AREA SUBJECT TO FINAL SURVEY
* BEARING AND DISTANCES SUBJECT TO FINAL SURVEY



R Sales Centre:
285 Annangrove Road, Rouse Hill



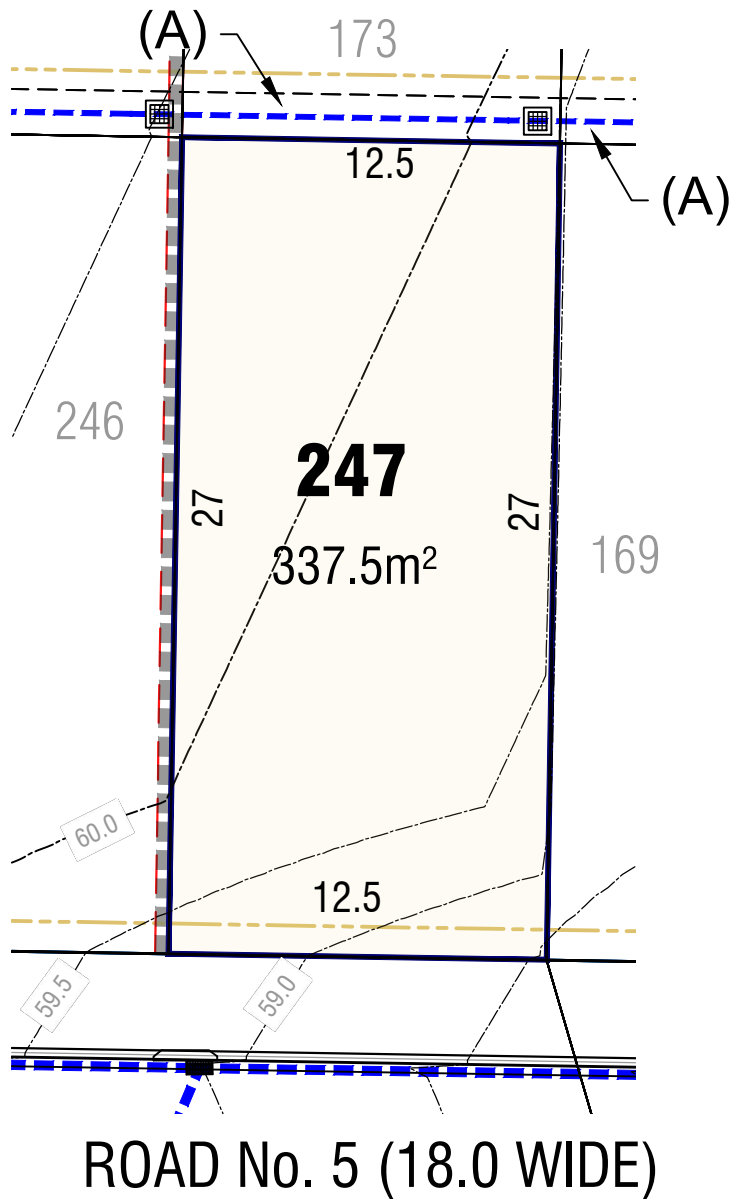

rousehillheights.com.au

This plan is provided solely for the purpose of providing an impression of the concept relating to the proposed development called 'Rouse Hill Heights', as well as the approximate location of existing and proposed third party facilities, services or destinations and is not intended to be used for any other purpose. Legacy Property does not make any representations or give any warranty in relation to the future development of the site, the staging of any future development or the current or future location or existence of any facilities, services or destinations. The plan is based on the present intention of, and information available to, Legacy Property and the current known requirements of relevant authorities at the time of creation of the plan and details may change due to future circumstances. Any indications of distance or size are approximate and for indicative purposes only, and are not to scale. The plan and any matters shown on or inferred from it do not give rise to a legally binding obligation on or representation or warranty by Legacy Property. Legacy Property accepts no liability for any loss or damage arising as a result of any reliance on this plan or its contents. Rouse Hill Heights is located in the suburb of Box Hill NSW 2765.



10/03/21

LEGEND

-  SEWER MAIN & ACCESS POINT
-  STORMWATER & PITS
-  50.0 DESIGN CONTOUR & LEVEL
-  Max. 1m RETAINING WALL

- (A) EASEMENT FOR DRAINAGE 1.5 WIDE
- (B) EASEMENT FOR MAINTENANCE & REPAIRS 0.9 WIDE

NOTE:
ALL CONTOURS HAVE INTERVAL OF 0.5m
(Contours are approximate only)

* AREA SUBJECT TO FINAL SURVEY
* BEARING AND DISTANCES SUBJECT TO FINAL SURVEY



R Sales Centre:
285 Annangrove Road, Rouse Hill

rousehillheights.com.au

This plan is provided solely for the purpose of providing an impression of the concept relating to the proposed development called 'Rouse Hill Heights', as well as the approximate location of existing and proposed third party facilities, services or destinations and is not intended to be used for any other purpose. Legacy Property does not make any representations or give any warranty in relation to the future development of the site, the staging of any future development or the current or future location or existence of any facilities, services or destinations. The plan is based on the present intention of, and information available to, Legacy Property and the current known requirements of relevant authorities at the time of creation of the plan and details may change due to future circumstances. Any indications of distance or size are approximate and for indicative purposes only, and are not to scale. The plan and any matters shown on or inferred from it do not give rise to a legally binding obligation on or representation or warranty by Legacy Property. Legacy Property accepts no liability for any loss or damage arising as a result of any reliance on this plan or its contents. Rouse Hill Heights is located in the suburb of Box Hill NSW 2765.